







SUGGESTED LIGHT SOURCE					
	<table border="1"> <thead> <tr> <th>Halogen</th> <th>LED</th> </tr> </thead> <tbody> <tr> <td>  6 x max 33W G9 HSGS </td> <td>  100/240V G9 </td> </tr> </tbody> </table>	Halogen	LED	 6 x max 33W G9 HSGS	 100/240V G9
Halogen	LED				
 6 x max 33W G9 HSGS	 100/240V G9				
220/240V - 50-60Hz					



AVVERTENZA

La sicurezza dell'apparecchio è garantita all'osservanza di queste istruzioni pertanto si raccomanda di conservarle.
Tutte le operazioni di montaggio, manutenzione e sostituzione lampadine, vanno eseguite assicurandosi che la rete di alimentazione sia disinserita.
Non deve essere superata la potenza massima indicata.



ATTENZIONE

L'installazione deve essere effettuata da installatori qualificati nel pieno rispetto della normativa.
Se il cavo flessibile esterno di questo apparecchio viene danneggiato, deve essere sostituito esclusivamente dal costruttore, dal suo servizio di assistenza o da personale qualificato equivalente, al fine di evitare pericoli.



WARNING

The safety of the fitting is guaranteed by the correct use of the following instructions. It is therefore necessary to keep them.
When carrying out all assembly, maintenance and lamp replacement operations, make sure that the power is off.
Do not exceed the maximum power indicated.



ATTENTION

The fitting should be installed by qualified installers to comply with the HD 384 standards. If the external flexible cable of this device is damaged, it has to be replaced only by the manufacturer, by its service assistance or by similar qualified personnel in order to avoid risks.



AVERTISSEMENT

La sûreté de l'appareil est garantie avec l'utilisation appropriée des instructions suivantes. Il est donc nécessaire de les garder.
Toutes les opérations de montage, entretien et remplacement de l'ampoule ne doivent être effectuées qu'après avoir coupé le courant.
Il ne faut pas dépasser la puissance maximum indiquée.



ATTENTION

L'installation doit être effectuée par des installateurs agréés, conformément à la norme HD 384.
Si le câble extérieur flexible de cet appareil est endommagé, il doit être remplacé exclusivement par le constructeur, son service d'assistance ou par du personnel équivalent qualifié, afin d'éviter tout danger.



SICHERHEITSHINWEISE

Die Sicherheit des Gerätes ist nur garantiert wenn die folgenden Vorschriften eingehalten werden. Es ist daher notwendig diese aufzubewahren.
Montage, Wartung und Lampenwechsel dürfen nur nach Unterbrechung des Netzanschlusses durchgeführt werden.
Nie die höchste angegebene Leistung überschreiten.



ACHTUNG

Die Leuchte ist von qualifizierten Fachleuten im Einklang mit der Bestimmung HD 384 zu installieren.
Wenn das externe flexible Kabel dieses Gerätes beschädigt ist, muss es nur durch den Hersteller, seinen Kundendienst oder einer ähnlich qualifizierten Person, um Gefahren zu vermeiden.

CORAL P

Design Villa Tosca, 2007

ISTRUZIONI DI MONTAGGIO ASSEMBLY ISTRUCTIONS INSTRUCTIONS DE MONTAGE MONTAGE ANLEITUNGEN

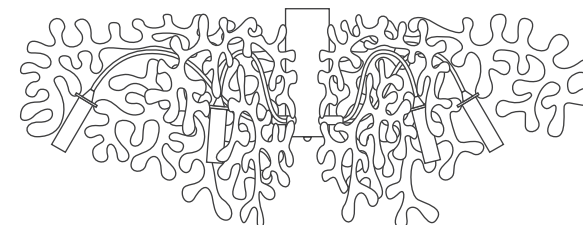

CERTIFICATION	
MADE IN ITALY	Certified production in Italy
Classe I	Class I
	Fixture fitted for direct assembly on normally inflammable surfaces.
IP20	Protected against the entry of solid objects larger than 12mm. No protection against the ingress of water.
CE	Product conforms to European Directive Community



IT - Il simbolo riportato sull'apparecchio indica che il prodotto deve essere smaltito in modo differenziato dai rifiuti urbani.
EN - The sign shown on the device indicates that the product must be thrown out in a different manner than with the urban trashes.
FR - Le symbole montré sur l'appareil indique que le produit doit être débarrassé de façon différente que les déchets urbains.
DE - Das auf dem Gerät wiedergegebene Symbol zeigt an, dass das Produkt getrennt vom Stadtmüll entsorgt werden muss.

CORAL P

LUMEN CENTER ITALIA S.r.l.
Via Donatori del Sangue 37 20010, S. Stefano Ticino (Mi) Italy
Italy: +39.02.36544311 - Export: +39.02.36544310
e-mail: info@lumencenteritalia.com - www.lumencenteritalia.com



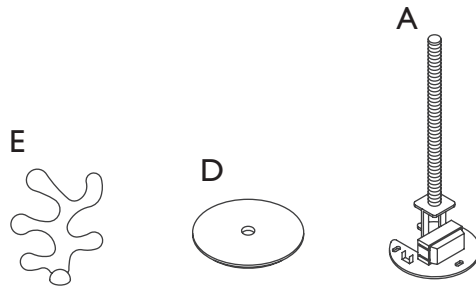
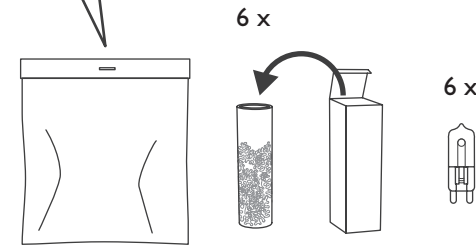
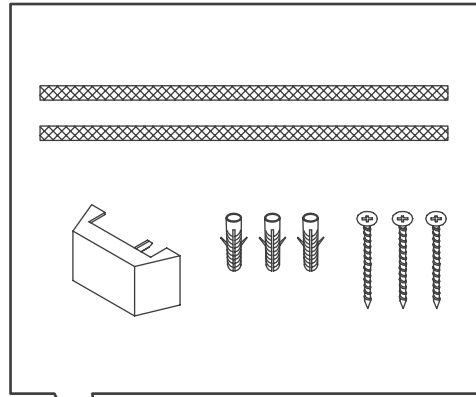

- 1** Fissare la staffa (A) al soffitto mediante gli appositi tasselli ad espansione. **1** Attach the bracket (A) to the ceiling, using wall specific expansion plugs. **1** Fixer l'étrier (A) au plafond par des chevilles à expansion appropriée. **1** Befestigen Sie den Steigbügel (A) an die Decke unter Verwendung der entsprechenden Dübel.

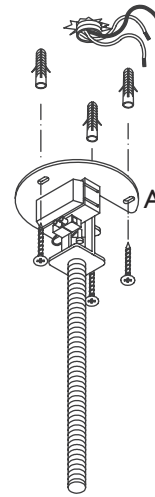

- 2** Effettuare i collegamenti elettrici connettendo i cavi di alimentazione al morsetto (B) dopo averli protetti con l'apposita guaina (C). **2** For electrical connections insert the feeder cables into the clamp (B), after protecting them with the proper sleeves (C). **2** Effectuer les connexions électriques en connectant les cables d'alimentation à la borne (B) après les avoir protégés au moyen de la gaine spéciale (C). **2** Die elektrischen Anschlüsse durch die Speisekabel, die zuerst durch den Kabel-manteln (C) geschützt werden müssen, an der Klemme (B) anschliessen.

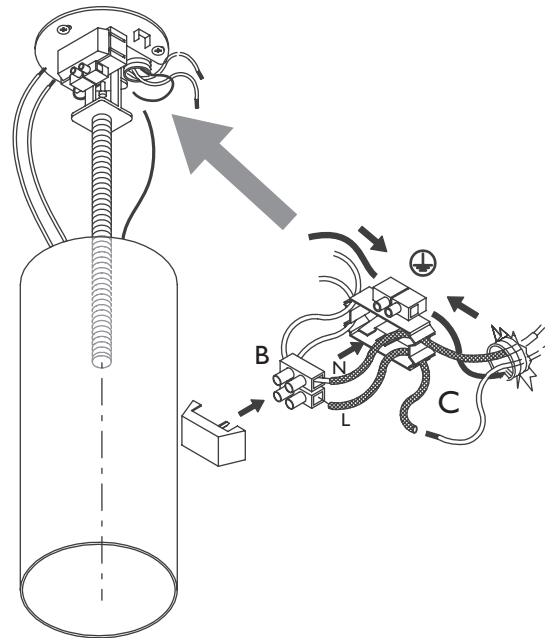

- 3** Fissare il corpo lampada tramite il dischetto (D) e il finale (E). **3** Fix the lamp structure through (D) disk and (E) final element. **3** Ensuite fixer le corps de la lampe avec le disque (D) et (E) élément final. **3** Den Leuchtenkörper durch Teile (D) und (E) fixieren.

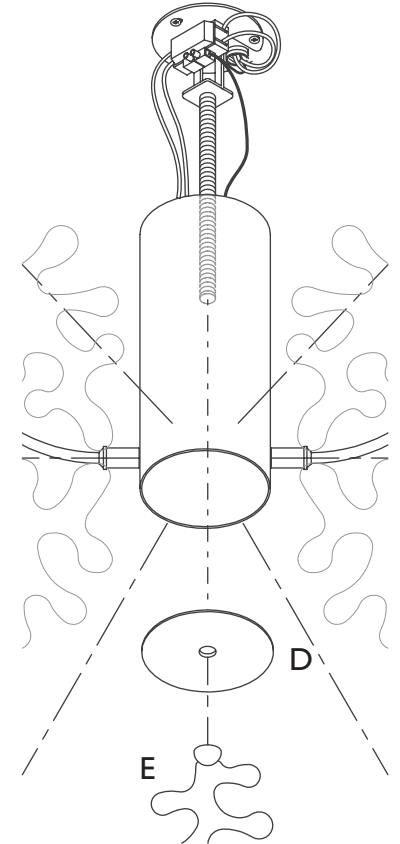

- 4** Inserire la lampadina. Inserire il vetro pirex (E) e fissarlo. **4** Insert the bulb. Insert pyrex glass (E) and fix it. **4** Insérer l'ampoule. Insérer le verre pirex (E) et le fixer. **4** Die Birne einsetzen. Glas (E) einführen.

6 x max. 33W G9 HSGS

